

C Series Double Channel Temperature Transmitter



→ Introductions

This temperature transmitter converts the thermocouple/thermal resistance signals to current or voltage signals. DIN rail power supply function can be selected in ordering.

The input, output, and power supply are galvanically isolated from each other. You can use handheld programmer to modify parameters or to calibrate the apparatus.

→ Parameters

Power supply:

Connection type: Terminals (14+, 15-) or DIN rail connector
Rated voltage: 18 V DC ~ 60 V DC (Recommended voltage: 24 V DC)

Input (1, 2, 3; 4, 5, 6):

TC: K, E, S, B, J, T, R, N, WRe3 - WRe25, WRe5 - WRe26
2/3-wire RTD: Pt100, Cu100, Cu50, BA1, BA2

The input signal needs to be determined when ordering and can also be programmed.

Line resistance: ≤ 20 Ω per line

Output (7, 8, 9; 10, 11, 12):

Sink mode: 4 ~ 20 mA
Output current: 0(4) ~ 20 mA; 0 ~ 10 mA
Output voltage: 0(1) ~ 5 V; 0 ~ 10 V
Output ripple: ≤ 5 mV_{rms} (Load resistance: 250 Ω)

Load resistance:

Sink mode: $R_L \leq [(U-3)/0.02] \Omega$; U: Loop power supply
0(4) ~ 20 mA: ≤ 550 Ω; 0 ~ 10 mA: ≤ 1.1 kΩ
0(1) ~ 5 V: ≥ 1 MΩ; 0 ~ 10 V: ≥ 2 MΩ

Transmission characteristics (25 °C ± 2 °C):

Input	Range	Accuracy
K/E/J/N/T	< 300 °C	± 0.3 °C
	≥ 300 °C	± 0.1% F.S.
S/B/R/WRe-series	< 500 °C	± 0.5 °C
	≥ 500 °C	± 0.1 % F.S.
Pt100/Cu100 Cu50/BA1/BA2	< 100 °C	± 0.1 °C
	≥ 100 °C	± 0.1 % F.S.

Response time: ≤ 0.5 s

Temperature drift: 30 ppm/°C

Cold junction compensation accuracy: ± 1 °C (Preheated for 10 minutes)

Cold junction compensation range: -20 °C ~ +60 °C

Electromagnetic compatibility: Accordance to IEC 61326-3-1

Dielectric strength (1 mA leakage current, 1 minute test time):

≥ 1500 V AC (Input /Output/Power supply)

Insulation resistance: ≥ 100 MΩ (Input /Output/Power supply)

Ambient conditions:

Operation temperature: -20 °C ~ +60 °C
Relative humidity: 10% RH ~ 90% RH (40 °C)
Atmosphere pressure: 80 kPa ~ 106 kPa
Storage temperature: -40 °C ~ +80 °C

Power dissipation:

1.2 W (24 V DC, double output)

→ Model rules

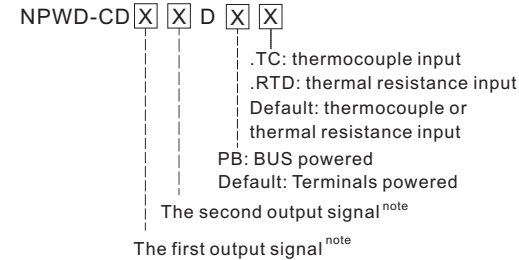

NOTE : Output signal

Number	Output signal
1	4 mA ~ 20 mA
2	1 V ~ 5 V
3	0 mA ~ 10 mA
4	0 V ~ 5 V
5	0 V ~ 10 V
6	0 mA ~ 20 mA
X	User customized signal type

→ Wiring diagram

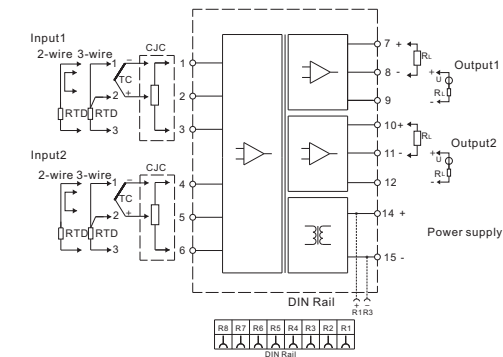

- Follow mode: Whatever input fault status (except breakage), the output follows the input within measuring range. And the maximum value would not exceed the 110% of the upper limit of the measuring range (e.g. When the output signal type is 0 ~ 20 mA, the minimum output value may be 0 mA, the maximum output value would not exceed 22 mA).
- When the thermocouple input, compensation conductor should be directly connected to the input terminals, do not connect other material lead, otherwise will cause measurement error.
- DIN rail power supply function is selectable at ordering.

→ Dimension

Width × Height × Depth: 17.8 mm × 110 mm × 117 mm

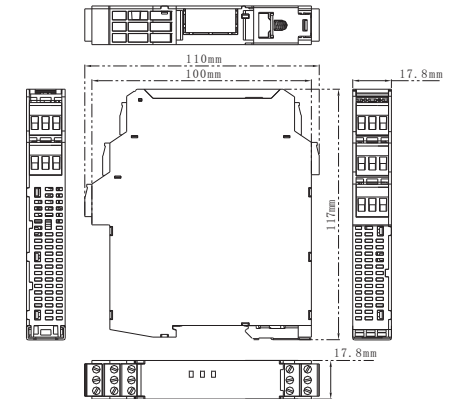

→ BUS Specification

BUS	Electrical Characteristics
Current	Max. 8 A
Voltage (UL/IEC)	1.6 kV
Operation temperature	-40 °C ~ +105 °C

→ Installation

- The apparatus can be installed on the DIN 35 mm standard rail which is corresponding to DIN IEC 60715. The must be snapped onto the rail, and never slanted or tipped to the side.
- Installation and disassembly steps are shown in following figures:

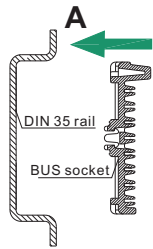

A. Snap the BUS socket on the DIN 35 rail, as figure A;

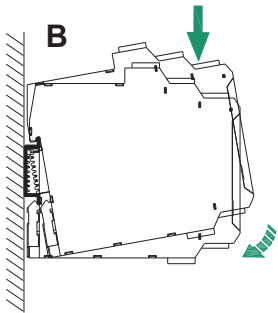

B. Snap metal lock onto mounting rail, then rotate the device, as figure B, press down the device onto mounting rail, make sure that the BUS connector pins of device and BUS socket are in close contact.

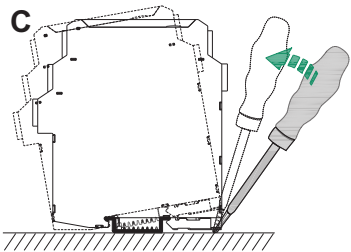

C. Pry the metal lock off the rail with screwdriver as arrow shown, pull downward the springs, and rotate the device.

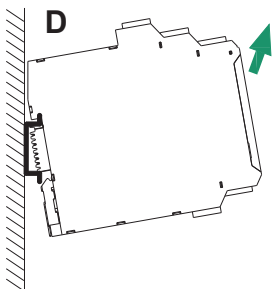

D. Remove the device as arrow shows.

- As far as possible to mount it vertically, In order to dissipation the heat of the apparatus.

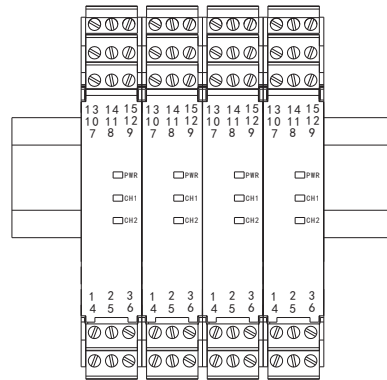

Vertically installation

→ Light indication

- **PWR**: Power indicator light shows green, it means work normally.
- **CH1, CH2**: Input signal state indicator (red), it is off during normal operation, remain bright when input over-range;
- **RTD**: It is glitter when input line breakage or short circuit;
- **TC**: It is glitter when input line breakage.

→ Attention

- The devices degree of protection is IP 20 and must be protected from undesirable ambient conditions (waterproofing, small foreign objects). It is suitable for installation in the control room or high density field cabinet, DIN 35 mm installation is convenient for installation and displacement.
- The devices were designed for use in pollution degree 2 and overvoltage category III as per IEC/EN 60664-1. If used in areas with higher pollution degree, the devices need to be protected accordingly.
- Installation position shall not be affected by strong mechanical vibration; impact and electromagnetic induction from signal terminal and power supply, should conformity with the requirements on electromagnetic

interference resistance of products in Class 3 industrial field atmosphere stipulated in IEC 61000-4; the atmosphere shall be free from gases that are corrosive to metal and plastic components.

- The apparatus must be installed, connected and adjusted by qualified personnel in non-hazardous area according with the instruction manual.
- The operator must strictly comply with the relevant local safety standards and guidelines.

→ Supplementary instructions

- Our company reserves the right to change the product information without prior notification to the user. If the contents of the description are different from website or sample, this description shall prevail.