

Features

- A base part and a plug-in protection module
- Patented large arc extinguisher technology
- Module unlock button, anti-vibration
- Status indicator, remote alarm
- Single-phase(TT) AC system
- 35 mm rail installation

Discription

According to IEC and GB standard , SPD can release high voltage pulse energy,and limit surge in a safety voltage level.

The complete device consists of a base module and plug-in protection modules and is ready for installation.

It is suitable for LPZ0_B ~ LPZ1 area and higher.

Parameter

Technology	MOV&GDT
Nominal voltage Un	230/400 Vac
Max. continuous operating voltage Uc	385 Vac(L-N), 255 Vac(N-PE)
Nominal discharge current In(8/20 μs)	20 kA
Max. discharge current I _{max} (8/20 μs)	40 kA
Voltage protection level Up	1.8 kV(L-N), 1.5 kV(N-PE)
Voltage protection level(5kA) Up	1.3 kV
Cross-sectional area (min.)	1.5 mm ² stranded / flexible
Cross-sectional area (max.)	25 mm ² stranded / flexible
Response time Ta	≤ 25 ns
Max. overcurrent protection	≤ 125 A gL/gG or SCB(P-SC-385/40x1P)
Remote communication function	P-FL-385/40xP+NR
Switching capacity	125 VAC/1A, 125 VDC/0.2A
Operating state / fault indication	Green / red
General parameters	
Operating temperature range	-40 °C ~ +80 °C
Installation	35 mm DIN
Enclosure dimensions (HxWxD)	90 mm x 36 mm x 66 mm
Location category	Indoor only
Enclosure material	Thermoplastic
Flame retardant grade(UL94)	V0
Protection degree	IP20
Standards	IEC 61643-11/ EN 61643-11
Power system	single-phase (TT system)



Graphics

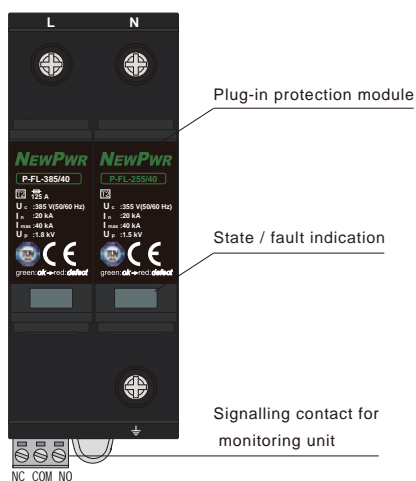

Schematic

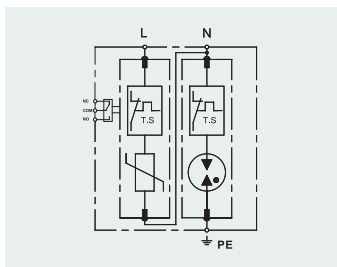

Dimensions

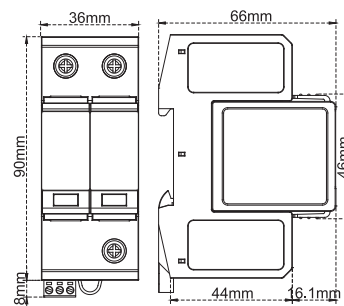

Application

