

NPEXA-C722
Isolated Safety Barrier



→ **Introductions**

This isolated safety barrier converts the RS232 digital signals from a hazardous area into RS232 digital signals to a safe area by isolation, and also provides transmitters with power in the hazardous area.

The input, output, and power supply are galvanically isolated from each other.

→ **Parameters**

Explosive-proof grade: [Ex ia Ga] IIC

Power supply:

Connection type: Terminals (14+, 15-)

Rated voltage: 18 V DC ~ 60 V DC

Input (1, 2, 3):

Input signal: RS232 digital signal

Control mode: half-duplex

Distribution (5, 6):

Distribution setting: Refer to rotary switch setting

Voltage tolerance: ± 10%

Output (7, 8, 9): RS232 digital signal

Transmission characteristics:

Transmission delay: ≤ 5 μs

Transmission rate: ≤ 56 kbps

Electromagnetic compatibility: Accordance to IEC 61326-3-1

Dielectric strength (1 mA leakage current, 1 minute test time):

≥ 3000 V AC (intrinsically safe side / non-intrinsically safe side)

≥ 1500 V AC (non-intrinsically safe side /non-intrinsically safe side)

Insulation resistance: ≥ 100 MΩ (Input /Output/Power supply)

Parameters certified by China National Quality Supervision and Test Centre for Explosion Protected Electrical Products (CQST):

U_m: 250 V

Terminals 1, 3; 2, 3:

U₀: 18.4 V I₀: 13 mA P₀: 60 mW C₀: 0.2 μF L₀: 70 mH

Terminals 5, 6:

U₀: 23.1 V I₀: 187 mA P₀: 1080 mW C₀: 0.07 μF

L₀: 0.4 mH

Ambient conditions:

Operation temperature: -20 °C ~ +60 °C

Relative humidity: 10% RH ~ 90% RH (40 °C)

Atmosphere pressure: 80 kPa ~ 106 kPa

Storage temperature: -40 °C ~ +80 °C

Power dissipation:

≤ 2 W (Distribution: 8 V/9 V/12 V, 50 mA)

≤ 3.5 W (Distribution: 5 V/6 V, 100 mA)

→ **Wiring diagram**

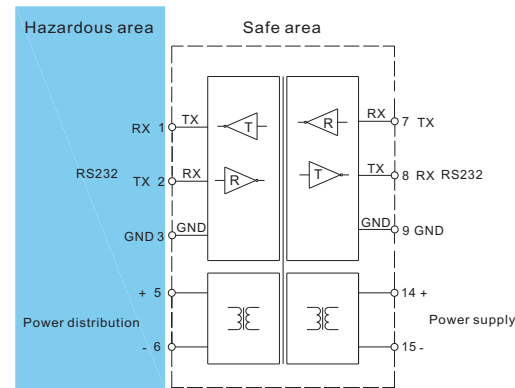

○ The transmission cable in the figure is recommended to use the shielded twisted pair.

→ **Power ON/OFF characteristics**

○ When power ON or power OFF, the bus dose not generate error.

→ **Safe state**

○ When the Communication bus port is fault, e.g. open-circuit or short-circuits, the DUT lead to a safe state.

→ **Dimension**

Width × Height × Depth: 17.8 mm × 110 mm × 117 mm

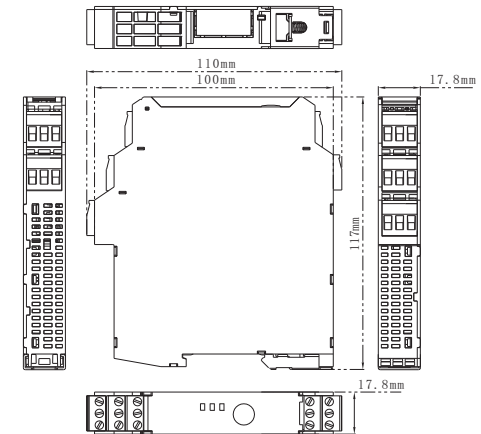

→ **Rotary switch setting**

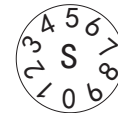

Rotary switch	Distribution
S0	5 V DC, 100 mA
S1	6 V DC, 100 mA
S2	8 V DC, 50 mA
S4	9 V DC, 50 mA
S8	12 V DC, 50 mA

→ **Applications**

This apparatus is used for transmitting signals between field devices and process control system. It can be used to connect field equipment which is installed in potentially explosive gas environment, and protect the intrinsically safe equipment in a hazardous area by limiting current and limiting voltage.

The apparatus can convert the RS232 digital signals from a hazardous area into RS232 digital signals to a safe area by isolation, and also provides transmitters with power in

Nanjing New Power Electric Co., Ltd.

the hazardous area.

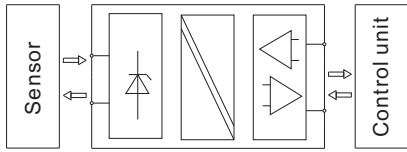

→ Installation

- The apparatus can be installed on the DIN 35 mm standard rail which is corresponding to DIN IEC 60715. The must be snapped onto the rail, and never slanted or tipped to the side.
- Installation and disassembly steps are shown in following figures:

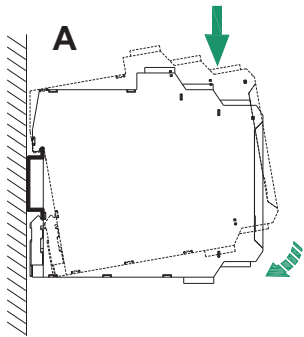

A. Snap metal lock onto mounting rail, then rotate the safety barrier, as figure A, press down the safety barrier onto mounting rail.

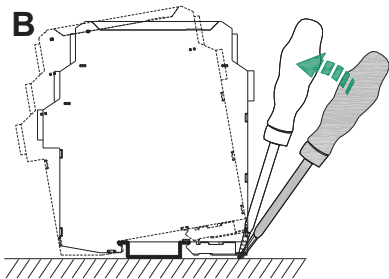

B. Pry the metal lock off the rail with screwdriver as arrow

shown, pull downward the springs, and rotate the safety barrier.

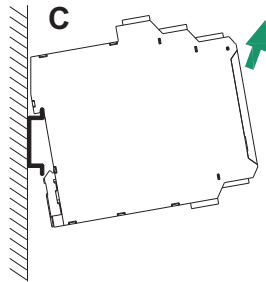

C. Remove the safety barrier as arrow shows.

- As far as possible to mount it vertically, In order to dissipation the heat of the apparatus.

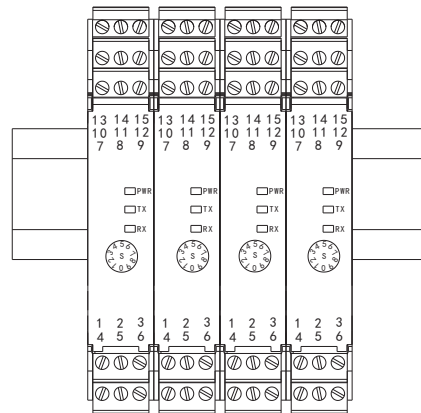

Vertically installation

→ Light indication

- **PWR**: Power indicator light shows green, it means work normally.
- **TX (yellow)**: The indicator flashes while data sending and turns on when sending data fails. Otherwise, the indicator turns off when normal.
- **RX (green)**: The indicator flashes while data receiving and turns on when receiving data fails. Otherwise, the indicator turns off when normal.

→ Attention

- Isolated Safety Barriers degree of protection is IP 20 and must be protected from undesirable ambient conditions (waterproofing, small foreign objects). It is suitable for installation in the control room or high density field cabinet, DIN 35 mm installation is convenient for installation and displacement.
- The devices were designed for use in pollution degree 2 and overvoltage category III as per IEC/EN 60664-1. If used in areas with higher pollution degree, the devices need to be protected accordingly.
- Installation position shall not be affected by strong mechanical vibration; impact and electromagnetic induction from signal terminal and power supply, should conformity with the requirements on electromagnetic interference resistance of products in Class 3 industrial field atmosphere stipulated in IEC 61000-4; the atmosphere shall be free from gases that are corrosive to metal and plastic components.
- The apparatus must be installed, connected and adjusted by qualified personnel in non-hazardous area according with the instruction manual.
- The operator must strictly comply with the relevant local safety standards and guidelines.

→ Supplementary instructions

- Our company reserves the right to change the product information without prior notification to the user. If the contents of the description are different from website or sample, this description shall prevail.